

TRAMONTINA

CASADELTA



Casa Delta

2023



CASA DELTA é uma coleção de móveis e acessórios para personalizar ambientes com estilo e criar espaços que reflitam o prazer de viver, o prazer de fazer bonito.

Os produtos **CASA DELTA** são desenhados com a paixão pelo design e produzidos com alta tecnologia pela Tramontina, sempre respeitando critérios de qualidade e sustentabilidade.

CASA DELTA is a furniture and accessories collection that will help you personalize rooms with your own style and create spaces which reflect the pleasure of living. The pleasure of doing things beautifully well.

The Tramontina **CASA DELTA** products have been designed with love and made with advanced technology while respecting quality and sustainability standards as always.

CASA DELTA es una colección de muebles y accesorios para personalizar ambientes con estilo y crear espacios que reflejen el placer de vivir. El placer de hacer bien las cosas.

Los productos **CASA DELTA** de Tramontina se diseñan con la pasión por el diseño y se producen con alta tecnología, siempre respetando criterios de calidad y sustentabilidad.

DESIGNERS

ZON DESIGN

Um estúdio brasileiro, especializado em design de produtos – equipe talentosa e criativa que pensa e faz design desde 1994, sempre inspirada na paixão pelo design, com visão no mundo globalizado e focada na síntese conceitual. ZON Design criou, em 2013, o conceito Casa Delta e os designs da primeira coleção de produtos [**Octo, Oca, Cona, Vira, Berta, Albero**].

A Brazilian studio specialized in product design – a talented and creative team that has been thinking and designing since 1994, always inspired by the passion for design, with a vision in the globalized world and focused on the conceptual synthesis. ZON Design created the Casa Delta concept in 2013, together with the designs for the first collection of products [**Octo, Oca, Cona, Vira, Berta, Albero**].

Un estudio brasileño, especializado en diseño de productos – equipo talentoso y creativo que piensa y hace diseño desde 1994, siempre inspirado por la pasión por el diseño, con visión en el mundo globalizado y enfocado en la síntesis conceptual. ZON Design creó, en el 2013, el concepto Casa Delta y los diseños de la primera colección de productos [**Octo, Oca, Cona, Vira, Berta, Albero**].

DESIGNERS ITALIANOS

ITALIAN DESIGNERS

DISEÑADORES ITALIANOS

Picco Foschia [**Paco**]

Valerio Bottin [**Jet**]

Softline Allkit [**Tonic**]

Groove Design [**Pepe**]

Natuzzi Dall'Aglio [**Flut**]

Azzolini Tinuper & Santantonio [**Salut**]

Tiziano Dainese [**Aloa**]

PROJETO ESPECIAL

SPECIAL PROJECT

PROYECTO ESPECIAL

Estudantes do Instituto Europeu de Design, IED. [**ELO**]

Students of European Design Institut, IED. [**ELO**]

Estudiantes del Instituto Europeo de diseño, IED. [**ELO**]

A EMPRESA

Tramontina, o prazer de fazer bonito.

Para a Tramontina, fazer bem feito é fazer com carinho, valorizando o bem estar que as pessoas sentem ao utilizarem produtos da Marca. É no prazer de fazer que a empresa e seus consumidores se encontram. Essa filosofia tem sido honrada pela Tramontina desde sua fundação, há mais de cem anos.

Hoje, a empresa conta com sete mil funcionários, responsáveis por um amplo mix de produtos para diferentes segmentos do mercado [utilidades e equipamentos para cozinha, eletros, móveis em madeira e em plástico, ferramentas para agricultura e jardinagem, ferramentas para construção, manutenção industrial e automotiva, materiais elétricos].

A postura de atuar de forma sustentável – fazendo bonito no cuidado com o meio ambiente e colaborando com as comunidades onde está presente – acompanha a Marca no Brasil e nos diferentes continentes onde atua, comercializando produtos em mais de 120 países.

A motivação e o prazer da Tramontina está na vontade de criar e de fazer bem feito para que seu consumidor possa fazer bonito em seu dia a dia, em sua vida.

TRAMONTINA

THE COMPANY

Tramontina, beautifully well done.

For Tramontina, to do things beautifully well is to do them with love, valuing the pleasure people feel when they use the brand's products. This pleasure of making things is where the company and its clients come together. Tramontina has honored this philosophy since its foundation, over one hundred years ago.

Today the company has seven thousand employees responsible for a wide range of products for different market segments such as kitchen utilities and equipments, wooden and plastic furniture, agriculture and garden tools, construction, industrial, automotive maintenance tools, and electrical hardware.

The posture of acting in a sustainable way – doing beautifully well when caring for the environment and collaborating with the communities where the company is present – accompanies the brand in Brazil and in the different continents where it operates, selling products in over 120 countries. Tramontina's motivation and pleasure lie in the desire to create and to do things beautifully well so that its clients can also do beautifully well in their daily lives.

LA EMPRESA

Tramontina, el placer de hacer bien las cosas.

Para Tramontina, hacer bien las cosas es hacerlas con cariño, valorando el bienestar de las personas al utilizar productos de la marca. Hacer que la marca y sus consumidores se encuentren en momentos de placer. Esa filosofía ha sido honrada por Tramontina desde su fundación, hace más de cien años.

Hoy, la empresa cuenta con siete mil empleados, responsables por un amplio mix de productos para diferentes ramos del mercado [utilidades y equipos para cocina, electrodomésticos, muebles de madera y de plástico, herramientas para agricultura y jardinería, herramientas para la construcción, mantenimiento industrial y automotriz, materiales eléctricos].

La postura de actuar de forma sustentable – haciendo bien las cosas por el cuidado del medio ambiente y colaborando con las comunidades donde está presente – acompaña a la marca en Brasil y en los diferentes continentes donde actúa, comercializando productos en más de 120 países. La motivación y el placer de Tramontina está en la voluntad de crear y hacer bien las cosas para que su consumidor puede lucirse en su día a día, en su vida.



Unidade Fabril Recife | RECIFE'S Plant | Unidad Fabril RECIFE

TRAMONTINA DELTA, fundada em 2000, está localizada em Recife, PE. Hoje, com 41.319 m² de área construída, distribuídos em duas unidades fabris [uma na capital Recife e outra na cidade de Moreno], conta com mais de 300 funcionários, que se ocupam da produção de móveis e acessórios em plástico: mesas, cadeiras, brinquedos, estantes e poltronas em plástico injetado ou rotomoldado – produtos fabricados com processos de alta tecnologia e com design que explora a beleza e a plasticidade do material.

TRAMONTINA DELTA was founded in 2000 and is located in Recife, PE, Brazil. Now it has a built-up area of 41,319 m² distributed across two manufacturing units [one in the capital city of Recife and the other in the town of Moreno]. It has over 300 employees, who produce plastic furniture and accessories: tables, chairs, toys, shelving units, and armchairs in injected or rotationally molded plastic – products made with high-technology processes and design exploring the beauty and plasticity of the material.

TRAMONTINA DELTA, fundada en 2000, esta ubicada en Recife, PE, Brasil. Actualmente cuenta con 41.319 m² de área construída, distribuídos en dos unidades fabriles [una en la capital, Recife, y otra en la ciudad de Moreno]. Tiene más de 300 empleados, que se encargan de la producción de muebles y accesorios de plástico: mesas, sillas, juguetes, estanterías y sillones de plástico inyectado o rotomoldeado – productos fabricados con procesos de alta tecnología y con diseño que explota la belleza y la plasticidad del material.



Unidade Fabril Moreno | MORENO Manufacturing Unit | Unidad Fabril MORENO

TRAMONTINA DELTA

Os móveis e acessórios apresentados neste catálogo são desenvolvidos pela **TRAMONTINA DELTA**, uma das unidades fabris Tramontina.

Produtos bonitos e práticos, para uso indoor ou outdoor, e adequados para ambientes residenciais e ambientes públicos [como bares, hotéis e restaurantes], empresariais, comerciais ou institucionais.

TRAMONTINA DELTA

The furniture items and accessories listed in this catalogue have been developed by **TRAMONTINA DELTA**, one of tramontina's factories.

Beautiful and practical products for indoor or outdoor use, perfect for residential spaces and public environments [such as bars, hotels, and restaurants], corporate, commercial, or institutional spaces.

TRAMONTINA DELTA

Los muebles y accesorios presentados en este catálogo son fabricados por **TRAMONTINA DELTA**, una de las unidades fabriles tramontina.

Productos bonitos y prácticos, para uso en interiores y exteriores y adecuados para ambientes residenciales y públicos [como bares, hoteles y restaurantes], empresariales, comerciales o institucionales.



OCA, 2014

Poltrona • Armchair • Sillón

Primeiro produto da coleção Casa Delta.

First product in the Casa Delta collection.

Primero producto de la colección Casa Delta.

TRAMONTINA NO MUNDO

TRAMONTINA AROUND THE WORLD

TRAMONTINA EN EL MUNDO

Lojas exclusivas da MARCA no Brasil e na América Latina.

Exclusive BRAND stores in Brazil and Latin America.

Tiendas exclusivas de la MARCA en Brasil y en América Latina.



112 anos de qualidade e inovação.

Presença da Marca em mais de 120 países.

Unidades próprias em 16 países.

Mix de produtos com mais de 18 mil diferentes itens.

112 years of quality and innovation.

Brand present in over 120 countries.

Own units in 16 countries.

Product mix with more than 18,000 different items.

112 años de calidad e innovación.

Presencia de la Marca en más de 120 países.

Unidades propias en 16 países.

Mix de productos con más de 18 mil artículos diferentes.

ESTRUTURA COMERCIAL | COMMERCIAL STRUCTURE | ESTRUTURA COMERCIAL

TRAMONTINA USA, INC. [TUSA]

12955 West Airport Boulevard - Sugarland
Texas 77478-6119 USA
Tel: 1 [281] 340.8400
tusa@tramontina-usa.com

TRAMONTINA GERMANY

Kamekestr. 21-50672 - Köln - Deutschland
Mob: +49 151 4643 8758 - Tel: +49 221 778 9991-0
info.tgermany@tramontina.com

TRAMONTINA DE MÉXICO S.A. DE C.V. [TEMEX]

Av. de la Palma, no. 8, Torre Acqua, 1º piso [Interlomas]
Col. San Fernando la Herradura
Huixquilucan - Edo. de México
Tel: [52-55] 5950.0470
temex@tramontina.com.mx

TRAMONTINA DE COLOMBIA E.U. [TECOL]

Km 1,5 Vía Siberia Parque empresarial Arcos de Cota Manzana B
Bodega 4 y 5, Potrero Chico - Cota [Cundinamarca]
Bogotá - Colombia
Tel: 57 [1] 623.4500
tecol@tramontina.com.co

TRAMONTINA DE CHILE LTDA [TCHILE]

Av. Andrés Bello 2233, Piso 4, Comuna de Providencia,
Santiago - Chile Rut: 77.479.170-1
Tel: [56.2] 2676.5000
tchile@tramontina.cl

TRAMONTINA AUSTRÁLIA

Tramontina Australia PTY | Unit 7, 167 Porspect
Hwy Seven Hills NSW 2147 Australia
TEL: + 61 2 9674 1799
info@tramontina.com.au

TRAMONTINA DEL ECUADOR S.A.

Av Rodrigo Chávez. Parque Empresarial Colón
Edificio Pacific Plaza - Piso 1 - Oficina 103
Telf: [593] 4 454 1794 / 4 461 2435
www.tramontina.com.ec
tecuador@tramontina.com.ec
Guayaquil - Ecuador

TRAMONTINA DEL PERU S.A.C [TPERU]

Av. Javier Prado, N°496 - Torre Las Orquídeas, Oficina 1002
San Isidro, Lima - 27, Peru - Tel: +51 [1] 421.2135/422.7580
tperu@tramontina.com.pe

TRAMONTINA AFRICA

Longpoint Business Park, Crn Witkoppen & Montecassino
Boulevard Fourways 2055
Johannesburg - South Africa
Tel: +27 11 300 9502
contact.africa@tramontina.net

TRAMONTINA SINGAPORE PTE LTD

9 Harrison Road, Level 6, S369651 Singapore
Tel: +54 6635.6264
info@tramontina.com.sg

TRAMONTINA CARIBE

RUC. 155631251-2-2016 DV. 13
Dirección: Av. Samuel Lewis, Calle 55, Obarrio - PH SL55, Piso 14
Oficina 14-2. Panamá, Ciudad de Panamá.
Teléfonos: 507 - 3099507 / 08 / 09
contacto.tcaribe@tramontina.com

TRAMONTINA RIGA

Vienibas gatve 109 Office 6.8; Riga, LV-1058 Latvia
Tel: +371 67304958 info.triga@tramontina.com
distribution centr: dc.triga@tramontina.com

TRAMONTINA CHINA

17/Floor Unit A&J, City Development Building, N°189 Tiyuxi Road,
Tianhe, Guangzhou Guangdong 510620, P.R. of China
Tel: [86.20] 3879.9701 / [86.20] 3879.6245

TRAMONTINA UK

Cannon Wharf Business Centre Pell Street [Sala 411]
London - SE85EN England
Tel: +44 [0] 20.3176.4558
contact@tramontina.uk

TRAMONTINA ESPANHA

Calle Santa Engracia 90, Piso 5, 28010, Madrid, Espanha
Tel: +34 915 76 78 30
contacto.tiberica@tramontina.com

TRAMONTINA PANAMÁ

RUC. 2185559-1-770972 DV. 18
Dirección: Carretera Panamericana, Tocumen, TOCUMEN OFFICE
STORAGE, Frente a Plaza Las Américas, Bodega #24.
Panamá, Ciudad de Panamá. 507 - 2038388 / 89
contacto.tpanama@tramontina.com

TRAMONTINA FRANÇA

3 rue Pierre Gilles de Gennes, Bat A, Salle 2B, 45000, Orléans
Tel: +33 745485872
contact.tfrance@tramontina.com

TRAMONTINA EMIRADOS ÁRABES [TDUBAI]

Saih Shuaib, 4 - Dubai Industrial City, Tramontina Building, Dubai
Industrial Park, P.O. Box 28924, Dubai, United Arab Emirates
Tel: +971 [4] 450 4301 / 4302
info.tdubai@tramontina.com

TRAMONTINA MALÁSIA

Level 32, Menara Prestige, No.1, Jalan Pinang, Kuala Lumpur
50450, Malaysia
Tel: +603 2728 1164
info.tmalaysia@tramontina.com

BRASIL | Centros de Distribuição

Nordeste [Simões Filho] - [71] 3215 8266
Norte [Belém] - [91] 4009 7700
Planalto [Goiânia] - [62] 3272 2100
Sudeste [São Paulo] - [11] 4197 1266
Sul [Carlos Barbosa] - [54] 3461 7700

BRASIL | Escritórios Regionais de Vendas

Belo Horizonte - [31] 3223 4026
Curitiba - [41] 2111 9110
Porto Alegre - [51] 2101 5000
Recife - [81] 3128 5500
Rio de Janeiro - [21] 2224 5004



Alguns produtos Casa Delta são produzidos em Plástico Verde* da Braskem, identificados com o selo I'M GREEN™.

Some Casa Delta products are produced in Braskem's Green Plastic*, identified with the I'M GREEN™ label.

Algunos productos Casa Delta se fabrican en Plástico Verde de Braskem, identificados con el sello I'M GREEN™.

*O Plástico Verde é produzido a partir da cana-de-açúcar. Possui as mesmas características do polietileno convencional, além de reduzir a emissão de gases do efeito estufa e ser 100% reciclável.

*Green Plastic is made from sugarcane. It has the same characteristics as conventional polyethylene, but it reduces the emission of greenhouse effect gases and is 100% recyclable.

*El Plástico Verde se produce a partir de la caña de azúcar. Tiene las mismas características del polietileno convencional, además de reducir las emisiones de los gases del efecto invernadero y de ser totalmente reciclable.



ÍNDICE

INDEX

ALOA	10
ALBERO	38
BERTA	22
ELO	36
FLUT	30
JET	25
MARILYN	28
OCA + CONA	17
OCA + CONA [LUMIÈRE]	19
OCA + CONA [INFANTIL]	20
OCTO + VIRA	13
PACO	14
PEPE	34
SALUT	33
TONIC	26
GUIA DE ESPECIFICAÇÕES	40
SPECIFICATIONS GUIDE	
GUÍA DE ESPECIFICACIONES	

ALOA



design
Tiziano Dainese

Design italiano. Conforto que agrega estilo e arquitetura ao ambiente.

Italian design. Comfort that adds style and architecture to the environment.

Diseño italiano. Confort que agrega estilo y arquitectura al ambiente.





OCTO + VIRA



Apoio **ou** **Banco**
 Table or / o Bench
 Apoyo ↔ Banco

design
ZON Design



Uma experiência estética para descansar o corpo e inspirar o olhar.

An aesthetic experience for relaxing the body and inspiring a certain look.

Una experiencia estética para descansar el cuerpo e inspirar la mirada.

PACO



design
Picco Foschia

Quadrada no exterior, redonda no interior. Poltrona com estilo e personalidade únicos.

Square on the outside, round on the inside. Armchair with unique style and personality.

Cuadrada en el exterior, redondo en el interior. Sillón con estilo y personalidad únicos.



Material exclusivo para clientes pessoa jurídica. | Exclusive material for legal entities/corporate clients. | Material exclusivo para clientes persona jurídica.



Material exclusivo para clientes pessoa jurídica. | Exclusive material for legal entities/corporate clients. | Material exclusivo para clientes persona jurídica.

OCA + CONA



design
ZON Design



Forma pura, conforto pleno e alegria no ambiente.

Simple shape that provides total comfort and enjoyment.

Forma pura, comodidad plena y alegría en el ambiente.



OCA + CONA [LUMIÈRE]



design
ZON Design



Iluminação LED, ampliando a beleza e o uso dos produtos.

LED lighting, enlarging the beauty and use of products.

Iluminación LED, ampliando la belleza y el uso de los productos.

OCA + CONA [INFANTIL]



design
ZON Design

Oca e Cona para os pequenos. Agora, todos os ambientes revestidos com design.

Oca and Cona for little ones. Now, all places covered with design.

Oca y Cona para los niños. Ahora, todos los ambientes revestidos con design.



BERTA



design
ZON Design

Um gesto expressivo e sinuoso, como as curvas de um grande arquiteto.

Expressive and winding, like the curves of a great architect.

Un gesto expressivo y sinuoso, como las curvas de un gran arquitecto.





Bistro
GOURMET

JET

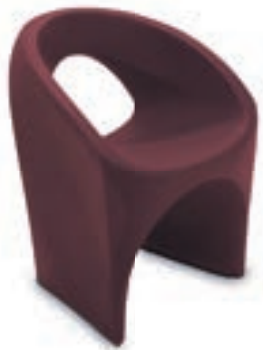

design
Valerio Bottin



Redonda e generosa, promete estilo e conforto de primeira classe.

Round and generous, it promises first-class style and comfort.

Redonda y generosa, promete estilo y comodidad de primera clase.

TONIC



design
Softline Allkit

Conforto e robustez. Uma presença escultural no ambiente.

Comfort and strength. A sculptural presence in the room.

Confort y robustez. Una presencia escultural en el ambiente.



MARILYN



design
ZON Design

Uma cadeira que abraça e veste a mesa. Totalmente em plástico.

A chair that hugs and dresses a table. 100% plastic.

Una silla que abraza y viste la mesa. Totalmente de plástico.



Material exclusivo para clientes pessoa jurídica. | Exclusive material for legal entities/corporate clients. | Material exclusivo para clientes persona jurídica.

FLUT



design
Natuzzi
Dall'Aglio

Versáteis e bem proporcionadas. Mesas para momentos de pura beleza e praticidade.

Versatile and well-proportioned. Tables for moments of pure beauty and practicality.

Versátiles y bien proporcionadas. Mesas para momentos de pura belleza y practicidad.



TRAMONTINA

TRAMONTINA



Material exclusivo para clientes pessoa jurídica. | Exclusive material for legal entities/corporate clients. | Material exclusivo para clientes persona jurídica.

SALUT



design
Azzolini Tinuper
& Santantonio



Uma versátil mesa com design que lembra a Natureza.

A versatile table whose design reminds Nature.

Una mesa versátil cuyo diseño remete a la Naturaleza.

PEPE



design
Groove Design

Um banco com características inconfundíveis, que agrega gosto ao espaço.

A stool with unmistakable features that adds taste to space.

Un banco con características inconfundibles, que le agrega buen gusto al espacio.



Material exclusivo para clientes pessoa jurídica. | Exclusive material for legal entities/corporate clients. | Material exclusivo para clientes persona jurídica.

ELO



design
Estudantes · Students
Estudiantes IED
Instituto Europeu de Design

Integração e modularidade. Para compor amplos ambientes com magnitude e robustez.

Integrated and modular. To decorate large areas with magnitude and strength.

Para componer amplos ambientes con magnitud y robustez.



Material exclusivo para clientes pessoa jurídica. | Exclusive material for legal entities/corporate clients. | Material exclusivo para clientes persona jurídica.

ALBERO



design
ZON Design

Mais que um simples cabide, uma homenagem à Natureza.

More than just a simple hanger, a tribute to Nature.

Más que un simple perchero, una homenaje a la Naturaleza.



POLTRONAS / ARMCHAIRS / SILLÓNS



OCA Design ZON Design

CATEGORIA / Category	Poltrona / Armchair / Sillón
MATERIAL	Polietileno / Polyethylene
USO / Use	Indoor – Outdoor
PESO DO PRODUTO / Product weight	6 kg
PESO MÁXIMO RECOMENDÁVEL / Maximum recommended weight	160 kg
DIMENSÕES / Dimentions / Dimensiones	
altura / height / altura	64 cm
largura / width / ancho	69,5 cm
profundidade / depth / profundidad	69,5 cm
altura assento / set height / altura asiento	37 cm

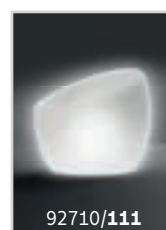

Acompanha controle remoto e carregador.
Remote control and charger included.
Viene con control remoto y cargador.

OCA LUMIÈRE Design ZON Design

CATEGORIA / Category	Poltrona / Armchair / Sillón
MATERIAL	Polietileno / Polyethylene
USO / Use	Indoor – Outdoor
PESO DO PRODUTO / Product weight	6 kg
PESO MÁXIMO RECOMENDÁVEL / Maximum recommended weight	160 kg
DIMENSÕES / Dimentions / Dimensiones	
altura / height / altura	64 cm
largura / width / ancho	69,5 cm
profundidade / depth / profundidad	69,5 cm
altura assento / set height / altura asiento	37 cm



JET Design Valerio Bottin

CATEGORIA / Category	Poltrona / Armchair / Sillón
MATERIAL	Polietileno / Polyethylene
USO / Use	Indoor – Outdoor
PESO DO PRODUTO / Product weight	5,8 kg
PESO MÁXIMO RECOMENDÁVEL / Maximum recommended weight	160 kg
DIMENSÕES / Dimentions / Dimensiones	
altura / height / altura	76 cm
largura / width / ancho	60 cm
profundidade / depth / profundidad	56 cm
altura assento / set height / altura asiento	45,5 cm

POLTRONAS / ARMCHAIR / SILLÓN

TRAMONTINA

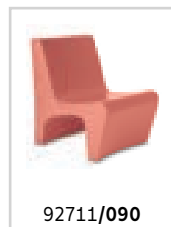
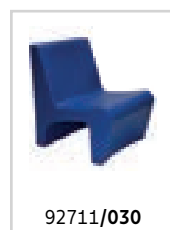
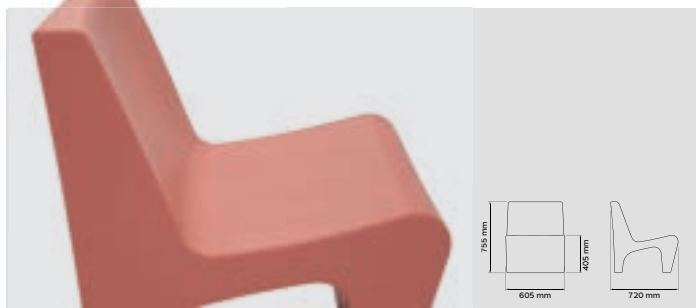

BERTA

Design ZON Design

CATEGORIA / Category	Poltrona / Armchair / Sillón
MATERIAL	
Material	Polietileno / Polyethylene
USO / Use	Indoor - Outdoor
PESO DO PRODUTO	
Product weight	
Peso del producto	9 kg
PESO MÁXIMO RECOMENDÁVEL	
Maximum recommended weight	
Peso máximo recomendable	160 kg
DIMENSÕES / Dimentions / Dimensiones	
altura / height / altura	75 cm
largura / width / ancho	60 cm
profundidade / depth / profundidad	71 cm
altura assento / set height / altura asiento	40,5 cm

POLTRONAS / ARMCHAIRS / SILLÓNS

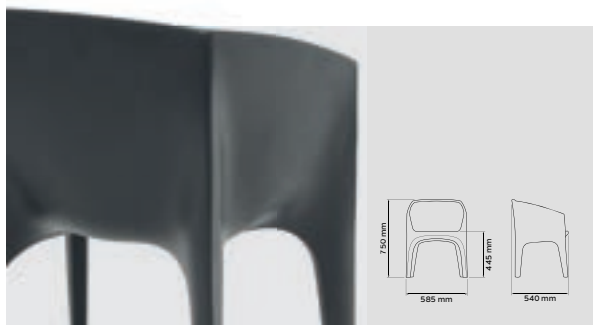

92715/007



92715/024



92715/034



92716/010



92716/050



92716/210



92715/054



92715/210



92715/220

PACO

Design **Picco Foschia**

CATEGORIA / Category	Poltrona / Armchair / Sillón
MATERIAL	Polietileno / Polyethylene
USO / Use	Indoor - Outdoor
PESO DO PRODUTO	
Product weight	
Peso del producto	6 kg
PESO MÁXIMO RECOMENDÁVEL	
Maximum recommended weight	
Peso máximo recomendable	160 kg
DIMENSÕES / Dimentions / Dimensiones	
altura / height / altura	75 cm
largura / width / ancho	58 cm
profundidade / depth / profundidad	54 cm
altura assento / set height / altura asiento	44 cm

TONIC

Design **Softline Allkit**

CATEGORIA / Category	Poltrona / Armchair / Sillón
MATERIAL	Polietileno / Polyethylene
USO / Use	Indoor - Outdoor
PESO DO PRODUTO	
Product weight	
Peso del producto	15 kg
PESO MÁXIMO RECOMENDÁVEL	
Maximum recommended weight	
Peso máximo recomendable	160 kg
DIMENSÕES / Dimentions / Dimensiones	
altura / height / altura	75 cm
largura / width / ancho	72 cm
profundidade / depth / profundidad	71 cm
altura assento / set height / altura asiento	43,5 cm

SOFÁ / SOFA / SOFA

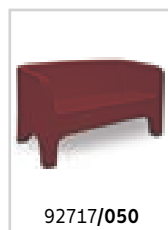
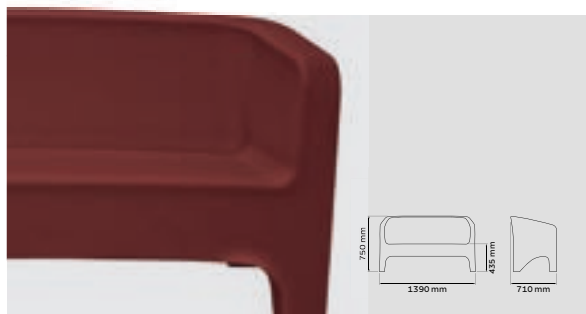

BANCO / BAR STOOL / BANCO



TONIC

Design **Softline Allkit**

CATEGORIA / Category	Sofá / Sofa / Sofa
MATERIAL	Polietileno / Polyethylene
USO / Use	Indoor - Outdoor
PESO DO PRODUTO	
Product weight	
Peso del producto	25 kg
PESO MÁXIMO RECOMENDÁVEL	
Maximum recommended weight	
Peso máximo recomendable	240 kg
DIMENSÕES / Dimentions / Dimensiones	
altura / height / altura	75 cm
largura / width / ancho	142 cm
profundidade / depth / profundidad	71 cm
altura assento / set height / altura asiento	43,5 cm

PEPE

Design **Groove Design**

CATEGORIA / Category	Banco / Bar Stool / Banco
MATERIAL	Polietileno / Polyethylene
USO / Use	Indoor - Outdoor
PESO DO PRODUTO	
Product weight	
Peso del producto	6,5 kg
PESO MÁXIMO RECOMENDÁVEL	
Maximum recommended weight	
Peso máximo recomendable	120 kg
DIMENSÕES / Dimentions / Dimensiones	
altura / height / altura	87 cm
largura / width / ancho	40,5 cm
profundidade / depth / profundidad	40,5 cm
altura assento / set height / altura asiento	82 cm

BANCOS / BENCHS / BANCOS

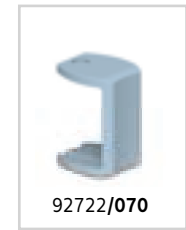
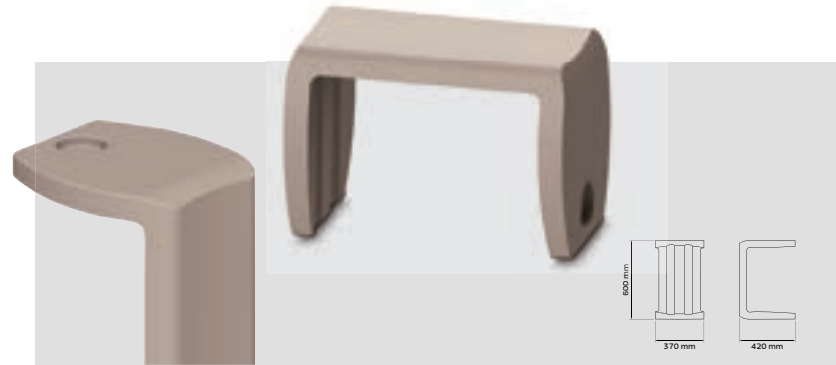
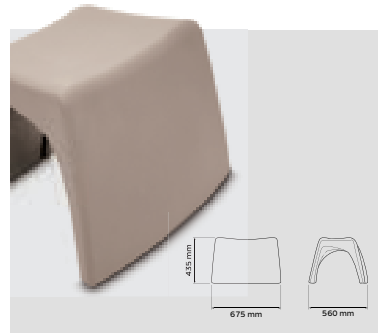
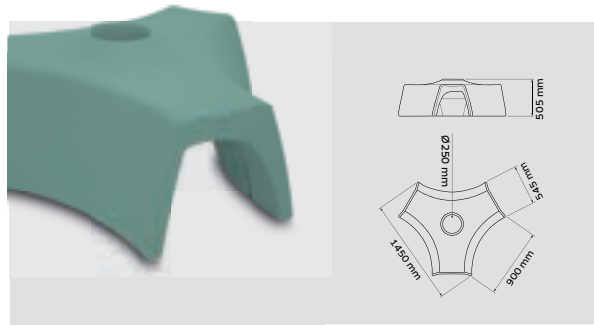

ELO CENTRAL Design Estudantes • Students • Estudiantes IED

CATEGORIA / Category	Banco / Bench / Banco
MATERIAL	Polietileno / Polyethylene
USO / Use	Indoor - Outdoor
PESO DO PRODUTO	
Product weight	
Peso del producto	20 kg
PESO MÁXIMO RECOMENDÁVEL	
Maximum recommended weight	
Peso máximo recomendable	300 kg
DIMENSÕES / Dimentions / Dimensiones	
altura / height / altura	49,5 cm
largura / width / ancho	124 cm
profundidade / depth / profundidad	146 cm
altura assento / set height / altura asiento	49,5 cm

ELO Design Estudantes • Students • Estudiantes IED

CATEGORIA / Category	Banco / Bench / Banco
MATERIAL	Polietileno / Polyethylene
USO / Use	Indoor - Outdoor
PESO DO PRODUTO	
Product weight	
Peso del producto	5 kg
PESO MÁXIMO RECOMENDÁVEL	
Maximum recommended weight	
Peso máximo recomendable	182 kg
DIMENSÕES / Dimentions / Dimensiones	
altura / height / altura	44 cm
largura / width / ancho	67 cm
profundidade / depth / profundidad	56 cm
altura assento / set height / altura asiento	44 cm

VIRA Design ZON Design

CATEGORIA / Category	Banco / Bench / Banco
MATERIAL	Polietileno / Polyethylene
USO / Use	Indoor - Outdoor
PESO DO PRODUTO	
Product weight	
Peso del producto	5,8 kg
PESO MÁXIMO RECOMENDÁVEL	
Maximum recommended weight	
Peso máximo recomendable	4 kg / 100 kg
DIMENSÕES / Dimentions / Dimensiones	
altura / height / altura*	60,5 cm
largura / width / ancho	37 cm
profundidade / depth / profundidad	42 cm
altura assento / set height / altura asiento**	42 cm

*apoio / table / apoyo
**banco / bench / banco

MESAS / TABLES / MESAS

TRAMONTINA

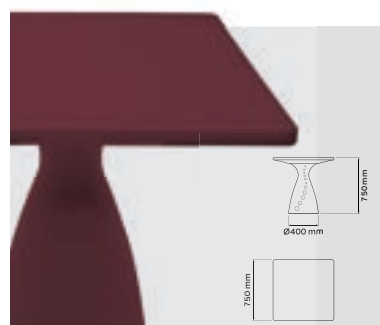

SALUT Design Azzolini Tinuper & Santantonio

CATEGORIA / Category	Mesa / Table / Mesa
MATERIAL	
Material	Polietileno / Polyethylene
USO / Use	Indoor - Outdoor
PESO DO PRODUTO	
Product weight	
Peso del producto	12 kg
DIMENSÕES / Dimentions / Dimensiones	
altura / height / altura	74,5 cm
largura / width / ancho	68,5 cm
profundidade / depth / profundidad	68,5 cm

FLUT REDONDA Design Natuzzi Dall'Aglio

CATEGORIA / Category	Mesa / Table / Mesa
MATERIAL	
Material	Polietileno / Polyethylene
USO / Use	Indoor - Outdoor
PESO DO PRODUTO	
Product weight	
Peso del producto	21 kg
DIMENSÕES / Dimentions / Dimensiones	
altura / height / altura	74 cm
largura / width / ancho	79,5 cm
profundidade / depth / profundidad	79,5 cm

FLUT QUADRADA Design Natuzzi Dall'Aglio

CATEGORIA / Category	Mesa / Table / Mesa
MATERIAL	
Material	Polietileno / Polyethylene
USO / Use	Indoor - Outdoor
PESO DO PRODUTO	
Product weight	
Peso del producto	22,7 kg
DIMENSÕES / Dimentions / Dimensiones	
altura / height / altura	74 cm
largura / width / ancho	75 cm
profundidade / depth / profundidad	75 cm

FLUT ALTA Design Natuzzi Dall'Aglio

CATEGORIA / Category	Mesa / Table / Mesa
MATERIAL	
Material	Polietileno / Polyethylene
USO / Use	Indoor - Outdoor
PESO DO PRODUTO	
Product weight	
Peso del producto	22,6 kg
DIMENSÕES / Dimentions / Dimensiones	
altura / height / altura	111 cm
largura / width / ancho	65 cm
profundidade / depth / profundidad	65 cm

MESAS DE APOIO / COFFEE TABLES / MESAS DE APOYO

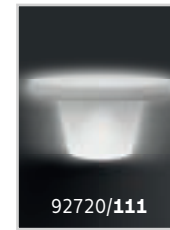
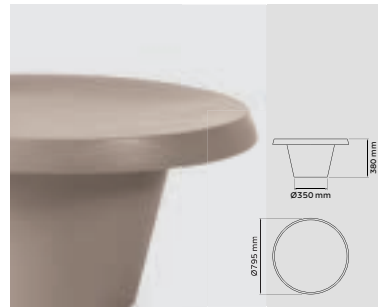
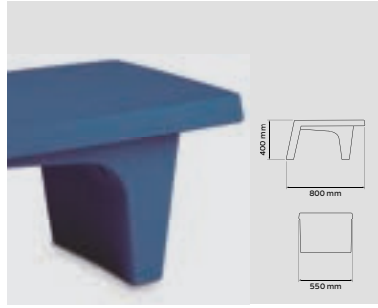

Acompanha controle remoto e carregador.
Remote control and charger included.
Viene con control remoto y cargador.

FLUT CENTRO Design Natuzzi Dall'Aglio

CATEGORIA / Category	Mesa / Table / Mesa
MATERIAL	
Material	Polietileno / Polyethylene
USO / Use	Indoor - Outdoor
PESO DO PRODUTO	
Product weight	
Peso del producto	9 kg
DIMENSÕES / Dimentions / Dimensiones	
altura / height / altura	50,5 cm
largura / width / ancho	65 cm
profundidade / depth / profundidad	65 cm

BERTA Design Zon Design

CATEGORIA / Category	Mesa / Table / Mesa
MATERIAL	
Material	Polietileno / Polyethylene
USO / Use	Indoor - Outdoor
PESO DO PRODUTO	
Product weight	
Peso del producto	7,5 kg
DIMENSÕES / Dimentions / Dimensiones	
altura / height / altura	40 cm
largura / width / ancho	80 cm
profundidade / depth / profundidad	54 cm

CONA Design ZON Design

CATEGORIA / Category	Mesa / Table / Mesa
MATERIAL	
Material	Polietileno / Polyethylene
USO / Use	Indoor - Outdoor
PESO DO PRODUTO	
Product weight	
Peso del producto	5 kg
DIMENSÕES / Dimentions / Dimensiones	
altura / height / altura	38 cm
largura / width / ancho	79 cm
profundidade / depth / profundidad	79 cm

CONA LUMIÈRE Design ZON Design

CATEGORIA / Category	Mesa / Table / Mesa
MATERIAL	
Material	Polietileno / Polyethylene
USO / Use	Indoor - Outdoor
PESO DO PRODUTO	
Product weight	
Peso del producto	5 kg
DIMENSÕES / Dimentions / Dimensiones	
altura / height / altura	38 cm
largura / width / ancho	79 cm
profundidade / depth / profundidad	79 cm

CADEIRA / CHAIR / SILLA



CABIDES / HANGERS / PERCHEROS

TRAMONTINA

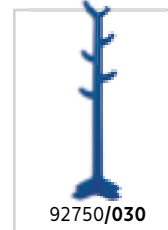

MARILYN

Design ZON Design

CATEGORIA / Category	Cadeira / Chair / Silla
MATERIAL	Polietileno / Polyethylene
USO / Use	Indoor - Outdoor
PESO DO PRODUTO	
Product weight	
Peso del producto	6 kg
PESO MÁXIMO RECOMENDÁVEL	
Maximum recommended weight	
Peso máximo recomendable	154 kg
DIMENSÕES / Dimentions / Dimensiones	
altura / height / altura	75 cm
largura / width / ancho	52 cm
profundidade / depth / profundidad	52 cm
altura assento / set height / altura asiento	45,5 cm

ALOA

Design Tiziano Dainese

CATEGORIA / Category	Poltrona / Armchair / Sillón
MATERIAL	Polietileno / Polyethylene
USO / Use	Indoor
PESO DO PRODUTO	
Product weight	
Peso del producto	6 kg
PESO MÁXIMO RECOMENDÁVEL	
Maximum recommended weight	
Peso máximo recomendable	160 kg
DIMENSÕES / Dimentions / Dimensiones	
altura / height / altura	83 cm
largura / width / ancho	57 cm
profundidade / depth / profundidad	59 cm
altura assento / set height / altura asiento	45 cm

ALBERO

Design ZON Design

CATEGORIA / Category	Cabide / Hanger / Perchero
MATERIAL	Polietileno / Polyethylene
USO / Use	Indoor - Outdoor
PESO DO PRODUTO	
Product weight	
Peso del producto	3,3 kg
PESO MÁXIMO RECOMENDÁVEL	
Maximum recommended weight	
Peso máximo recomendable	15 kg
DIMENSÕES / Dimentions / Dimensiones	
altura / height / altura	171 cm
largura / width / ancho	51 cm
profundidade / depth / profundidad	51 cm

INFANTIL / KIDS / NIÑO

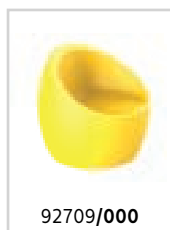
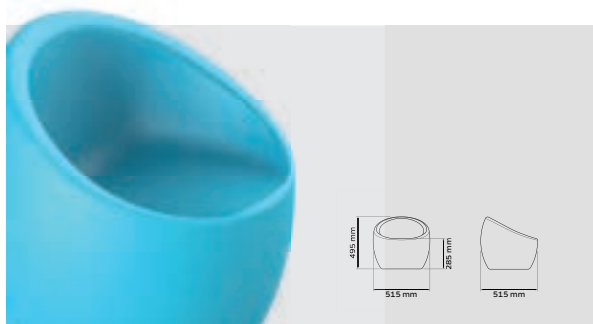

Acompanha controle remoto e carregador.

Remote control and charger included.

Viene con control remoto y cargador.

OCA INFANTIL

Design ZON Design

CATEGORIA / Category	Poltrona Infantil/ Kids Armchair / Sillón Niños
MATERIAL	Polietileno / Polyethylene
USO / Use	Indoor - Outdoor
PESO DO PRODUTO	
Product weight	
Peso del producto	4 kg
PESO MÁXIMO RECOMENDÁVEL	
Maximum recommended weight	
Peso máximo recomendável	100 kg
DIMENSÕES / Dimentions / Dimensiones	
altura / height / altura	49,5 cm
largura / width / ancho	53 cm
profundidade / depth / profundidad	53 cm
altura assento / set height / altura asiento	28 cm

CONA INFANTIL

Design ZON Design

CATEGORIA / Category	Mesa Infantil/ Kids Table / Mesa Niños
MATERIAL	Polietileno / Polyethylene
USO / Use	Indoor - Outdoor
PESO DO PRODUTO	
Product weight	
Peso del producto	4 kg
DIMENSÕES / Dimentions / Dimensiones	
altura / height / altura	30 cm
largura / width / ancho	65 cm
profundidade / depth / profundidad	65 cm

OCA INFANTIL LUMIÈRE

Design ZON Design

CATEGORIA / Category	Poltrona Infantil/ Kids Armchair / Sillón Niños
MATERIAL	Polietileno / Polyethylene
USO / Use	Indoor - Outdoor
PESO DO PRODUTO	
Product weight	
Peso del producto	4 kg
PESO MÁXIMO RECOMENDÁVEL	
Maximum recommended weight	
Peso máximo recomendável	100 kg
DIMENSÕES / Dimentions / Dimensiones	
altura / height / altura	49,5 cm
largura / width / ancho	53 cm
profundidade / depth / profundidad	53 cm
altura assento / set height / altura asiento	28 cm

CHAISE / LOUNGE CHAIR / REPOSERA

TRAMONTINA

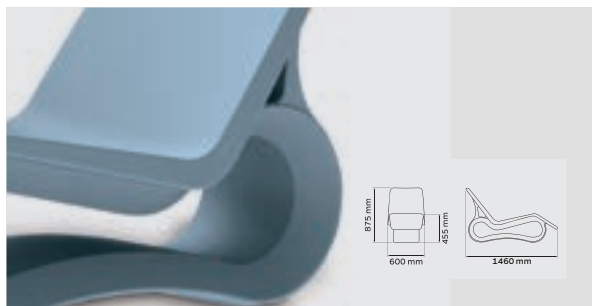

92713/010



92713/030



92713/070



92713/090



92713/210

OCTO

Design ZON Design

CATEGORIA / Category	Chaise Lounge Chair / Reposera
MATERIAL	Polietileno / Polyethylene
USO / Use	Indoor - Outdoor
PESO DO PRODUTO	
Product weight	
Peso del producto	18 kg
PESO MÁXIMO RECOMENDÁVEL	
Maximum recommended weight	
Peso máximo recomendable	160 kg
DIMENSÕES / Dimentions / Dimensiones	
altura / height / altura	85 cm
largura / width / ancho	58,5 cm
profundidade / depth / profundidad	146 cm
altura assento / set height / altura asiento	46 cm

CORES DE PRODUCTOS / 2023

PRODUCT'S COLORS / COLORES DEL PRODUCTOS

/000 106 C AMARELO YELLOW / AMARILLO	/007 433 C GRAFITE GRAPHITE / GRAFITO	/009 BLACK C PRETO BLACK / NEGRO	/010 COOL GRAY 1 C BRANCO WHITE / BLANCO
/020 584 C VERDE PISTACHE GREEN PISTACHIO / VERDE PISTACHE	/030 7692 C AZUL MARINER BLUE MARINER / AZUL MARINER	/050 7641 C MARSALA BURGUNDY / VIÑO	/060 226 C ROSA PINK / ROSA
/070 2708 C AZUL CLARO LIGHT BLUE / AZUL CLARO	/070 3125C AZUL BLUE / AZUL	/090 7416 C LARANJA ORANGE / NARANJA	/111  ILUMINADA LED / ILUMINADA
/210 WARM GRAY 4 C CONCRETO CONCRETE / GRIS	/220 5565 C VERDE SÁLVIA GREEN SAGE / VERDE SALVIA		

PRODUCTOS I'M GREEN BIO BASED

I'M GREEN BIO-BASED PRODUCTS

PRODUCTOS I'M GREEN BIO-BASED

/054 7641 C MARSALA BURGUNDY / VIÑO	/034 7692 C AZUL MARINER BLUE MARINER / AZUL MARINER	/024 584 C VERDE PISTACHE GREEN PISTACHIO / VERDE PISTACHE
---	---	---

/000		
NOME	REF.	PANTONE
OCA INFANTIL	92709	106C
CONA INFANTIL	92719	106C

/007		
NOME	REF.	PANTONE
JET	92712	433C
PACO	92715	433C
PEPE	92700	433C
SALUT	92732	433C
FLUT QUADRADA	92742	433C
FLUT ALTA	92743	433C
FLUT CENTRO	92740	433C

/010		
NOME	REF.	PANTONE
OCA	92710	COOL GRAY 1C
BERTA POLTRONA	92711	COOL GRAY 1C
TONIC SOFÁ	92716	COOL GRAY 1C
TONIC POLTRONA	92717	COOL GRAY 1C
PEPE	92700	COOL GRAY 1C
VIRA	92722	COOL GRAY 1C
SALUT	92732	COOL GRAY 1C
FLUT REDONDA	92741	COOL GRAY 1C
FLUT QUADRADA	92742	COOL GRAY 1C
FLUT ALTA	92743	COOL GRAY 1C
FLUT CENTRO	92740	COOL GRAY 1C
CONA	92720	COOL GRAY 1C
BERTA MESA	92721	COOL GRAY 1C
OCTO	92713	COOL GRAY 1C

/090		
NOME	REF.	PANTONE
OCA	92710	7416C
BERTA POLTRONA	92711	7416C
VIRA	92722	7416C
OCTO	92713	7416C

/024		
NOME	REF.	PANTONE
JET	92712	584C
PACO	92715	584C

/034		
NOME	REF.	PANTONE
JET	92712	7692C
PACO	92715	7692C

/054		
NOME	REF.	PANTONE
JET	92712	7641C
PACO	92715	7641C

/070		
NOME	REF.	PANTONE
OCA INFANTIL	92709	3125C
CONA INFANTIL	92719	3125C

/070		
NOME	REF.	PANTONE
VIRA	92722	2708C
ALBERO	92750	2708C
OCTO	92713	2708C

/030		
NOME	REF.	PANTONE
MARILYN	92714	7692C
OCA	92710	7692C
BERTA POLTRONA	92711	7692C
VIRA	92722	7692C
CONA	92720	7692C
BERTA MESA	92721	7692C
ALBERO	92750	7692C
OCTO	92713	7692C

/020		
NOME	REF.	PANTONE
OCA	92710	584C
BERTA POLTRONA	92711	584C

/220		
NOME	REF.	PANTONE
ELO CENTRAL	92726	5565C
ELO APOIO	92727	5565C
MARILYN	92714	5565C
OCA	92710	5565C
JET	92712	5565C
PACO	92715	5565C
ALBERO	92750	5565C
ALOA	92718	5565C

/060		
NOME	REF.	PANTONE
OCA INFANTIL	92709	226C
CONA INFANTIL	92719	226C

/111		
NOME	REF.	PANTONE
OCA	92710	--
CONA	92720	--
OCA INFANTIL	92709	--

/009		
NOME	REF.	PANTONE
ALOA	92718	BLACK C

/210		
NOME	REF.	PANTONE
MARILYN	92714	WARM GRAY 4C
OCA	92710	WARM GRAY 4C
JET	92712	WARM GRAY 4C
BERTA POLTRONA	92711	WARM GRAY 4C
PACO	92715	WARM GRAY 4C
TONIC SOFÁ	92716	WARM GRAY 4C
TONIC POLTRONA	92717	WARM GRAY 4C
PEPE	92700	WARM GRAY 4C
VIRA	92722	WARM GRAY 4C
SALUT	92732	WARM GRAY 4C
FLUT QUADRADA	92742	WARM GRAY 4C
FLUT ALTA	92743	WARM GRAY 4C
FLUT CENTRO	92740	WARM GRAY 4C
CONA	92720	WARM GRAY 4C
BERTA MESA	92721	WARM GRAY 4C
ALBERO	92750	WARM GRAY 4C
OCTO	92713	WARM GRAY 4C
ALOA	92718	WARM GRAY 4C
ELO CENTRAL	92726	WARM GRAY 4C
ELO APOIO	92727	WARM GRAY 4C

/050		
NOME	REF.	PANTONE
TONIC SOFÁ	92716	7641C
TONIC POLTRONA	92717	7641C
PEPE	92700	7641C
SALUT	92732	7641C
FLUT QUADRADA	92742	7641C
FLUT ALTA	92743	7641C
FLUT CENTRO	92740	7641C
CONA	92720	7641C
ALOA	92718	7641C

COMMERCIAL INFORMATIONS FOR EXPORT MARKETS | INFORMACIONES COMERCIALES PARA EXPORTACIÓN

SALES CONDITIONS

1. The prices stated on this price list are gross and at FOB Brazilian Port basis.
2. We suggest that our customers always try to place orders in full containers for a safer and shorter-time transportation as well as a better rate instead of shipment by LCL.
3. The requested quantities will be adjusted according to the factory's package.
4. Country of Origin: Brazil.
5. For imported items certificate of origin will not be emitted.
6. Payment terms:

A] USD – U.S. Dollar

For telegraphic transfer, please use the following bank:

- Intermediary Bank
Standard Chartered Bank / New York / USA
Swift Code: SCBLUS33 – ABA 02600256
- Beneficiary Bank
Banco Itaú BBA S. A. / São Paulo / Brazil
Swift Code: ITAUBRSPNHO
Account: 3544030205001
- Final Beneficiary
Tramontina Delta S. A.
Av Barão do Bonito, 1110 – Várzea
Recife / PE / Brazil
CEP: 50740-080
Banco Itaú BBA S. A.
Branch: 0773
Account: 00004-7
IBAN: BR71 6070 1190 0077 3000 0000 047C 1
- Reference
Please make reference to the invoice number.

B] EUROS

Please send it to:

- Bank
Commerzbank Ag / Dusseldorf / Germany
Swift Code: COBADEDD
Account: 600067151101 EUR
- Beneficiary Bank
Banco Itaú BBA S. A. / São Paulo Head Office
Swift Code: CBBABRSP
Tramontina Delta S. A.
AG.: 0773 CC: 00004/7
- Final Beneficiary
Tramontina Delta S. A.
Av Barão do Bonito, 1110 – Várzea – Recife / PE / Brazil
CEP: 50740-080
Phone|Fax: [55] 81 3425-7119
- Reference
Pro-forma invoice number and/or contract number.
Beneficiary: Tramontina Delta S. A.
Av Barão do Bonito, 1110 – Várzea – Recife / PE / Brazil
CEP: 50740-080 - CNPJ: 02.508.145/0001-23
Phone: [55] 81 3454-8800 – Fax: [55] 81 3454-880

7. When effecting payments by telegraphic transfer, always indicate Tramontina Delta as the beneficiary, the number of Proforma of Commercial Invoice and send a copy of it to the fax number [55] 81 3454 8827 to the attention of Export Department.

LETTER OF CREDIT [L/C] – OPENING INSTRUCTIONS

- Credit must be irrevocable and payable at sight.
- Latest date of shipment to be considered is [max.] 60 days after the proforma invoice's final confirmation.
- The limit for the presentation of the documents to the Brazilian bank has to be 21 days after shipment.
- Port of shipment: any Brazilian Port.
- Transshipment and partial shipments must be allowed.
- L/C must bear a 5% variation in quantity and amount.
- L/C opening charges and all other bank charges outside Brazil will be on applicant's account.
- In case one single L/C is opened covering the credit of various Tramontina's companies, it must indicate "transferable credit" and also the name of all beneficiaries [according to the proforma invoices].
- The L/C application form [draft] must be sent in advance of the L/C opening for an evaluation and final approval sent by fax +55 81 3454 8801 Att. To Export Department; or directly by e-mail to the trader who you are in touch with.
- Otherwise, whether L/C amendments would be needed; the costs will be on applicant's account.

All payments must be sent to this bank:
Banco Itaú BBA S. A. / São Paulo
Swift Code: CBBABRSP
Rua Siqueira Campos, 833, Sobreloja
CEP: 90.010-000 – Porto Alegre, RS – Brasil

CONDICIONES DE VENTA

1. Los precios en esta lista son brutos y FOB Puertos Brasileños.
2. Sugerimos a nuestros clientes que siempre ajusten sus pedidos para llenar contenedores completos de 20 ó 40 pies a fin de lograr un transporte más seguro, rápido y económico si comparado a embarque LCL.
3. Las cantidades solicitadas siempre van a ser ajustadas al embalaje de fábrica.
4. Origen de las mercaderías: Brasil.
5. Productos importados, no tiene Certificado de Origen.
6. Condiciones de pago:

A] USD – U.S. Dollar [Dólar Americano]

Para pagos através de transferencia bancaria, favor utilizar uno de los siguientes bancos:

- Intermediary Bank
Standard Chartered Bank / New York / USA
Swift Code: SCBLUS33 – ABA 02600256
- Beneficiary Bank
Banco Itaú BBA S. A. / São Paulo / Brazil
Swift Code: ITAUBRSPNHO
Account: 3544030205001
- Final Beneficiary
Tramontina Delta S. A.
Av Barão do Bonito, 1110 – Várzea
Recife / PE / Brazil
CEP: 50740-080
Banco Itaú BBA S. A.
Branch: 0773
Account: 00004-7
IBAN: BR71 6070 1190 0077 3000 0000 047C 1
- Referencia
Haga referencia con su numero de invoice.

B] EUROS

Considere lo siguiente banco:

- Banqueiro
Commerzbank Ag / Dusseldorf / Germany
Swift Code: COBADEDD
Account: 600067151101 EUR
- Beneficiary Bank
Banco Itaú BBA S. A. / São Paulo Head Office
Swift Code: CBBABRSP
Tramontina Delta S. A.
AG.: 0773 CC: 00004/7
- Final Beneficiary
Tramontina Delta S. A.
Av Barão do Bonito, 1110 – Várzea – Recife / PE / Brazil
CEP: 50740-080
Phone|Fax: [55] 81 3425-7119
- Referencia
Nº da fatura pró-forma e/ou nº de contrato de câmbio
Av Barão do Bonito, 1110 – Várzea – Recife / PE / Brazil
CEP: 50740-080 – CNPJ: 02.508.145/0001-23
Phone: [55] 81 3454-8800 – Fax: [55] 81 3454-880

7. Al efectuar la transferencia, favor apuntar Tramontina Delta como el beneficiario y el número da la Factura Comercial Invoice. Enviar copia de la transferencia al fax [55] 81 3454 8827 a la atención del Departamento de Exportación.

DATOS BANCARIOS PARA APERTURA DE CARTA DE CRÉDITO [L/C] CRÉDITO [L/C]

- El crédito debe ser irrevocable y pagable a la vista.
- La última fecha de embarque deberá ser [max.] 60 días después de la fecha confirmación de la factura proforma.
- El límite para la entrega de los documentos en el banco brasileño debe ser 21 días después del embarque.
- Puerto de embarque: cualquier puerto brasileño.
- Transbordos y embarques parciales permitidos.
- La L/C debe permitir una variación de 5% en cantidad y monto total de la mercadería.
- Las tasas de apertura de la L/C así como todas las demás tasas bancarias afuera de Brasil deberán ser por cuenta del aplicante.
- Si la L/C considera proformas de varias empresas de Tramontina, el documento debe indicar "crédito transferible" e identificar los nombres de los demás beneficiarios.
- El formulario de apertura [SWIFT] de la L/C deberá ser enviado para análisis y aprobación final directamente por e-mail a la persona con la cual mantiene contacto o vía fax +55 81 34548801 en Att. Departamento de Exportación. Al contrario, cualquier costo relativo a enmiendas será por cuenta del aplicante.

Todos los pagos deberán ser en ese banco:
Banco Itaú BBA S. A. / São Paulo
Swift Code: CBBABRSP
Rua Siqueira Campos, 833, Sobreloja
CEP: 90.010-000 – Porto Alegre, RS – Brasil

INFORMAÇÕES GERAIS

GENERAL INFORMATION | INFORMACIONES GENERALES

IMAGEM DO PRODUTO

Algumas imagens apresentadas neste catálogo são meramente ilustrativas.

MODIFICAÇÕES NOS PRODUTOS

A Tramontina reserva-se o direito de modificar qualquer produto presente neste catálogo, visando seu aperfeiçoamento, sempre que existirem razões técnicas ou comerciais para isso. Qualquer alteração que seja efetivada está isenta de avisos prévios e não obriga a reposição dos produtos já vendidos.

ITENS CANCELADOS OU DESCONTINUADOS

A Tramontina reserva-se o direito de retirar de produção ou anular a comercialização de qualquer produto presente neste catálogo.

MEDIDAS E PESOS

Os valores relativos a pesos e medidas contidos neste catálogo estão sujeitos a modificações.

PRODUCT IMAGE

Some of the images displayed in this catalog are for illustration only.

ALTERATIONS TO PRODUCTS

Tramontina reserves the right to modify any product present in this catalog with the intention of improving it whenever there are technical or commercial reasons to do so. Any alteration already effective is therefore exempt from prior notice and from the obligation of replacing products already sold.

CANCELED OR DISCONTINUED ITEMS

Tramontina reserves the right to remove from production or stop the sale of any product present in this catalog.

WEIGHTS AND MEASUREMENTS

The values related to weights and measurements contained in this catalog are subject to modifications.

IMAGEN DEL PRODUCTO

Algunas imágenes de este catálogo son meramente ilustrativas.

MODIFICACIONES EN LOS PRODUCTOS

Tramontina se reserva el derecho de modificar cualquier producto de este catálogo, con el objetivo de mejorarlo, siempre que existan razones técnicas o comerciales para eso. Cualquier alteración que se realice no necesita ser avisada previamente y no obliga la empresa a reponer los productos vendidos.

ARTÍCULOS CANCELADOS O DESCONTINUADOS

Tramontina se reserva el derecho de retirar de producción o anular la comercialización de cualquier producto de este catálogo.

MEDIDAS Y PESOS

Los valores relativos a pesos y medidas de este catálogo están sujetos a modificaciones.

CENTRO DE DISTRIBUIÇÃO ESCRITÓRIOS REGIONAIS DE VENDAS

DISTRIBUTION CENTERS | REGIONAL SALES OFFICES

CENTROS DE DISTRIBUCIÓN | OFICINAS REGIONALES DE VENTAS





CENÁRIO / SETTING / ESCENARIO

Residência Condomínio Velas da Marina - Capão da Canoa/RS

Residência Condomínio Villagio de Firenze - Gravataí/RS

Le Bistrô Restaurante - Porto Alegre/RS

FOTOGRAFIA / PHOTOGRAPHY / FOTOGRAFÍA

Débora Zandonai

PRODUÇÃO / PRODUCTION / PRODUCCIÓN

Arq. Rodrigo Buglione e ZON Design

CRIAÇÃO E DIREÇÃO DE ARTE

CREATION AND ART MANAGEMENT

CRIACIÓN Y DIRECCIÓN DE ARTE

ZON Design



TRAMONTINA

TRAMONTINA DELTA S.A.

Av. Barão do Bonito, 1110 | Bairro da Várzea | CEP 50740-080
Recife | PE | Brasil | CNPJ 02.508.145/0001-23
Indústria Brasileira

